

Goedhart DRS

Industrial air coolers for cooling and working rooms
StSt/Al

$\text{NH}_3 - \text{CO}_2$



Goedhart DRS

The Goedhart DRS range of dual discharge ceiling mounted air coolers consists of 240 types with capacities between 3,8 and 200,9 kW. The aircoolers are especially suitable for cooling and working room applications. The height of the aircooler is low, so the maximum space in the chill room can be utilised. The fans are arranged for blow-through or draw-through air configuration (please state which is required when ordering). The modular design incorporates 5 different sizes of fan, with model options of up to 6 fans per cooler. The fans are mounted to the outside of the air cooler. The fans are as standard not wired on a junction box to the connection side. Wiring is available against an extra price.

Coil block

- Tube pitch : 50x50 mm straight
- Fin spacings : 4, 7 and 10 mm
- Material : 15mm o.d stainless steel 304 tubes
- : aluminium HT-fins
- Optimized cooling circuits
- The coil block is standard build from aluminium end plates, stainless steel 304 tubes and aluminium fins.
- A good thermal contact is achieved by hydraulic expansion of the tubes into the fin collars, that are also utilised as spacers to provide a constant distance between the fins.
- All coolers are pressure tested to 30 bar (lower by cooling mediums) and are supplied with a light over pressure charge of dry nitrogen.
- Standard the air coolers are suitable for NH₃ - pumpcirculation (ratio 2/4).

Type-description

Goedhart DRS 66457

Number of rows deep
 Number of fans
 Fan diameter [cm]
 Fin spacing [mm]

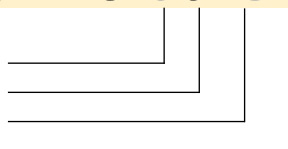

Casing

- Construction for ceiling mounting
- The flush mounting protects against and prevents accumulation of dust and dirt.
- Casing material of galvanized sheet steel
- Finishing is standard white epoxy spray (RAL 9003)
- Bend/header projection by end covers, easy removed for maintenance
- Hinged drip tray.
- Defrost by hot gas spiral or electric defrost elements will be fixed to the bottom side of the coil
- Stainless steel fasteners.

General range features

Capacity

The listed nominal cooling capacities are based on NH₃, DT1, a RH of 85% and 4 pole 3 phase fans connected in D.

Influence of Coating on Capacity

The use of coated fins, or of a fully coated coil will result in a capacity decrease of approximately 3%

Capacity optimisation

Since Goedhart tries to limit stock products, we are capable of optimising the circuitry of our evaporators. In order to do this, the following information is needed :

- Design capacity
- Air volume
- Refrigerant
- Air on temperature
- Evaporating temperature
- Liquid temperature before expansion valve.

Sound data

The mean sound pressure (LpA @ 3m ± 2 dB (A)) each air cooler is a calculated indication value according to the EN13487 standard parallel pipe. Goedhart uses the fan manufacturer's sound power level (LwA) at the inlet side of the fan. Changes to or by the fan or the product, affect the sound, in these cases, consult the manufacturer for the new indication value. In critical sound requirements, we advise you to consult an expert.

Defrostsystem:

For room temperatures where ice build-up can be expected and where the coilblock can not be defrosted by the room air, electric or hotgas defrost is necessary.

With low temperatures we also advise fan periphery heating.

Electrical defrost:

The Goedhart DRS can be provided with electric defrost. A distinction can be made here between heavy defrost loads for low temperatures and light defrost load for higher temperatures (room temperature approximately 0 °C).

The stainless steel heater elements are fitted in the coilblock in tubes, which forms a high conductive medium between the heaters and the fins. The driptray heaters are fitted to the underside of the aluminium inner tray with aluminium profiles. The heater elements which are rated for 220/240 V are connected for supply 380/415 V with neutral. The coilblock

elements are removable from the end opposite to the refrigerant connections, whilst the tray heater elements can be removed once the outer tray has been taken off.

Hotgas defrost:

The coilblock can be made suitable for hotgas. At an extra price the driptray can be provided with a hotgas/cooling medium spiral. The stainless steel tubes of the hotgas spiral are enclosed in special aluminium profiles that are rigidly secured to the underside of the aluminium inner tray, thus providing a good bond for maximum heat transfer. Just as with electric defrost a distinction is made with hotgas defrost between light defrost load (room temperature about 0°C) and heavy defrost load.

Accessoires:

Voor de Goedhart DRS luchtcoolers zijn de volgende accessoires leverbaar:

- fans wired on a junction box to the connection side.
- Electric, hotgas defrost system.
- Insulation within the driptray.
- Insulated hygienic polyester driptray.
- Insulated fan plate

The accessories are included in the price list.

Optional extras:

Various optional extras for the Goedhart DRS are available, price and delivery upon request:

- Insulation discs
- Feet for floor mounting
- Hinged fan plates
- Other fin spacings
- Sea water resistant fins
- 60 Hz motors
- EC-fans
- Single phase motors
- Glycol/water/etc. cooling mediums,
- NH₃ dx, R22 dx/pumpsystem.
- Other casing material
- Stainless steel 316 tubes

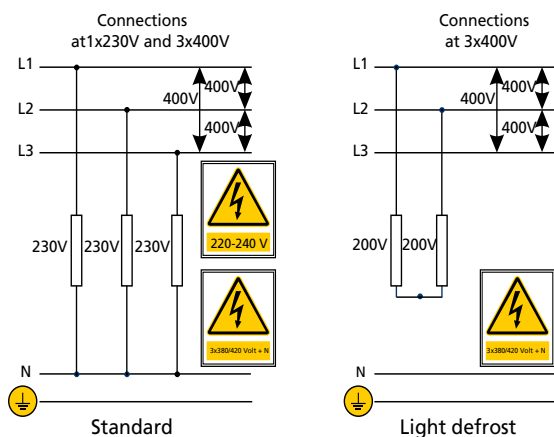

Mounting and Maintenance

Goedhart DRS is delivered on a wooden frame. When on the frame, Goedhart DRS can be handled by forklift truck, which makes positioning and installation simple. Refer to our maintenance and installation manual..



Fans

Because of the flexible construction of the Goedhart DVS air cooler, in principle it is possible to deliver with different fans. GEA Goedhart selected a standard fan range of Ziehl Abegg (we reserve the right to alter the manufacturer) which fit perfectly on the Goedhart DVS air coolers. The fans can be supplied in both blow-through and draw-through executions. The fans are mounted to the outside of the air cooler. The fans are standard not wired (wiring is optional) on a junction box to the connection side. Against an extra price and with extra delivery times stainless steel guards and EC-fans are available.

Execution

The fans meet the ErP directive. The fans have very good aerodynamic features because of the special impeller geometry. This special impeller geometry gives the fan a low noise level and an high efficiency.

1x230V fans are suitable for a room temperature till -25°C. 3x400V fans are suitable for a room temperature till -40°C. When lower room temperatures are desired, special fans are need.

- Tension : 3x400V-50Hz-3 phase
: 1x230V-50Hz-1 phase
(60Hz execution on request)
- Protection class : IP44 / IP54
- Color : RAL9005 (black)
- Speed controlling : - 3 Phase motors are suitable for 2-speed regulation by Δ-Y reconnection.
- 3 Phase motors are suitable for frequency controller with all-pole sinus filter.
- 1 Phase motors are suitable for phase control and transformer.

The motors are standard executed with a thermo contact (TB) and must be connected to prevent motor damages. The maximum allowable working data in the table and on the name plate of the fans are to operate in an air temperature of 20 °C (air density of $\rho = 1,2 \text{ kg/m}^3$). For air temperatures lower then +20 °C, the current amperage can be calculated by using the diagram multiplication factor, suitable thermal overloads can then be selected.

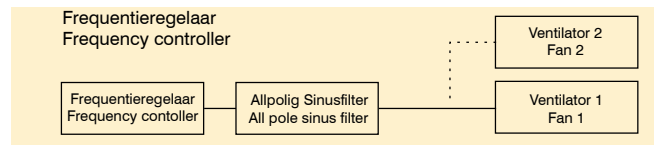
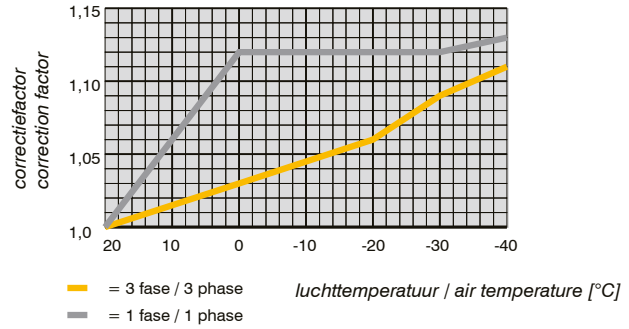

Three phase - 50 Hz

Fan type	Tension V	Δ				Y				Wiring diagram blow-through/ draw-through
		Speed min ⁻¹	Input Watt	FLC A	Sound power indication each fan LwA (+/-2dB(A)) dB(A)	Seed min ⁻¹	Input Watt	FLC A	Sound power indication each fan LwA (+/-2dB(A)) dB(A)	
4 pole (n=1500 min⁻¹ nom.)										
FN040	3x400/690	1370	230	0.44	76	1110	170	0.27	70,5	108B/108A
FN045	3x400/690	1250	350	0.64	78	950	220	0.35	70	108B/108A
FN050	3x400/690	1330	830	1.45	81	940	550	0.97	75	108B/108A
FN056	3x400/690	1280	1050	2.20	85	920	580	1.10	76	108B/108A
FE063	3x400/690	1330	1450	2.60	89	1080	980	1.60	84	108B/108A
6 pole (n=1000 min⁻¹ nom.)										
FN045	3x400/690	860	180	0.39	67	640	100	0.19	61	108B/108A
FN050	3x400/690	870	290	0.74	72	590	150	0.36	64	108B/108A
FN056	3x400/690	870	340	0.70	73	630	210	0.38	65	108B/108A
FN063	3x400/690	900	630	1.25	74	720	440	0.73	69	108B/108A

Single phase - 50 Hz

Fan type	Speed min ⁻¹	Input Watt	FLC A	Sound power indication each fan LwA (+/-2dB(A)) dB(A)	Wiring diagram blow-through/ draw-through
4 pole (n=1500 min⁻¹ nom.)					
FN040	1350	240	1.10	76	104B/104A
FN045	1290	390	1.75	80	104B/104A
FN050	1230	750	3.35	81,5	104B/104A
6 pole (n=1000 min⁻¹ nom.)					
FN040	950	130	0.58	68	104B/104A
FN045	860	180	0.82	68,5	104B/104A
FN050	910	300	1.30	71,5	104B/104A

Wiring diagram fans for blow-through air coolers

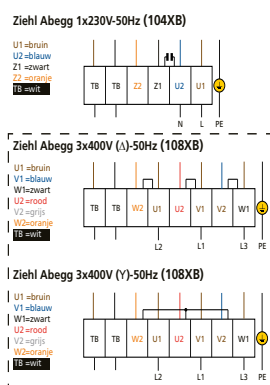

Wiring diagram fans for draw-through air coolers

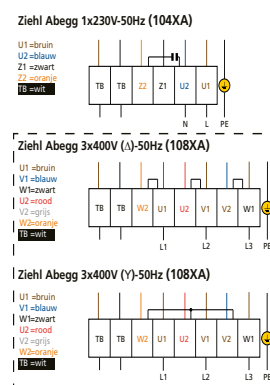

Correction factors

Capacities at DT1:

Hereby the capacities are based on NH₃ pump system and DT1. DT1 is the difference between air-on temperature and the evaporation temperature of the cooler. The evaporation temperature is the saturated temperature corresponding to the pressure at the suction outlet of the cooler. The nominal capacities are based on evaporation temperatures of -8°C and DT1=8K and light frosting. Capacities for other mediums and systems are available upon request.

Correction factors for various air-on temperatures and temperature differences (DT1) are as indicated in the table below. The requested capacity must be multiplied by a correction factor from the table, so that a cooler with the resulting nominal capacity can be chosen from the selection tables.

$$Q_{\text{nominal}} = \text{factor} \times Q_{\text{requested}}$$

R404A light frost = 0.2 mm RV = 85%

DT1 K	Evaporation temperature (°C)						
	0	-2,5	-5	-7,5	-10	-12,5	-15
6	1.29	1.34	1.39	1.43	1.47		
7	1.06	1.11	1.14	1.17	1.21		
8	0.90	0.94	0.97	1.00	1.02		
9	0.78	0.80	0.84	0.86	0.88		
10	0.68	0.70	0.74	0.76	0.78		
11	0.61	0.63	0.66	0.68	0.69		
12	0.54	0.56	0.59	0.60	0.62		

R404A normal frost = 0.5 mm RV= 85%

DT1 K	Evaporation temperature (°C)						
	0	-2,5	-5	-7,5	-10	-12,5	-15
6		1.48	1.52	1.57	1.61		
7		1.22	1.26	1.29	1.33		
8		1.04	1.07	1.09	1.12		
9			0.92	0.95	0.97		
10			0.81	0.83	0.85		
11			0.72	0.74	0.76		
12			0.65	0.67	0.68		

Attention!

ATTENTION !!!

When making your selection, pay attention to the ratio between the air volume and capacity. A low volume to capacity ratio results in a wide temperature drop across the coil which cause to dry out (especially on coils with a high number of rows deep).

Goedhart DRS 4mm

Type DVS	3x400V-50H-4pole (1500 min ⁻¹ nom.)			3x400V-50H-6pole (1000 min ⁻¹ nom.)			Surface	Internally volume	Weight	Dimensions								Connections			
	R404A		LpA @ 3 m (+/-2 dB(A))**	R404A		LpA @ 3 m (+/-2 dB(A))**				L	B	H	C	E1	E2	E3	E4	Refrigerant			
	DT1 = 8K (SC2) Air on= 0°C	Air volume		DT1 = 8K (SC2) Air on= 0°C	Air volume													in	out	Hot gas	Drain

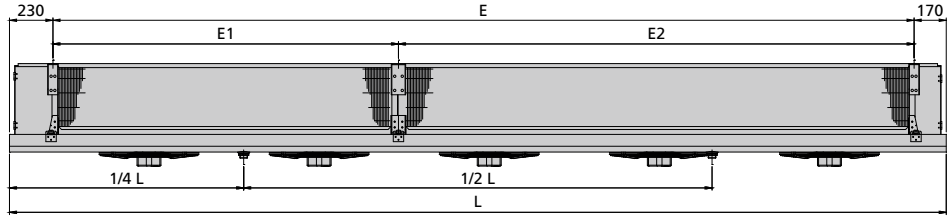
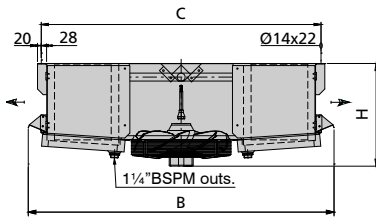

1x	3.1.40.4	6,9	3168	54,3	5,4	2119	46,3	29	6	97	1056	1220	420	1080	656				21,3	21,3	4x22	2x1¼"
	4.1.40.4	7,8	2998	54,3	6,0	2021	46,3	39	6	108	1056	1320	420	1180	656				21,3	21,3	4x22	2x1¼"
	6.1.40.4	8,7	2713	54,3	6,5	1852	46,3	59	10	131	1056	1520	420	1380	656				21,3	21,3	4x22	2x1¼"
	3.1.45.4	9,8	4728	56,2	7,9	3293	45,2	39	6	111	1056	1370	520	1130	656				21,3	26,7	4x22	2x1¼"
	4.1.45.4	11,1	4445	56,2	8,9	3136	45,2	52	8	123	1056	1370	520	1230	656				21,3	26,7	4x22	2x1¼"
	6.1.45.4	12,5	3994	56,2	9,7	2876	45,2	78	12	150	1056	1570	520	1430	656				21,3	26,7	4x22	2x1¼"
	3.1.50.4	14,6	7081	59,1	11,7	4854	50,1	59	10	149	1356	1320	520	1180	956				21,3	26,7	4x22	2x1¼"
	4.1.50.4	16,9	6824	59,1	13,2	4654	50,1	78	12	168	1356	1420	520	1280	956				21,3	33,7	4x22	2x1¼"
	6.1.50.4	19,6	6375	59,1	14,5	4295	50,1	117	18	203	1356	1620	520	1480	956				21,3	33,7	4x22	2x1¼"
	3.1.56.4	20,2	9933	62,8	16,3	6759	50,8	81	12	179	1456	1380	620	1240	1056				21,3	33,7	4x22	2x1¼"
4.1.56.4	23,7	9623	62,8	18,4	6527	50,8	108	16	200	1456	1480	620	1340	1056				21,3	33,7	4x22	2x1¼"	
6.1.56.4	27,7	9096	62,8	20,5	6096	50,8	163	24	247	1456	1680	620	1540	1056				21,3	33,7	4x22	2x1¼"	
3.1.63.4	24,7	12114	66,6	20,5	8780	51,6	98	14	206	1456	1450	720	1310	1056				21,3	33,7	4x22	2x1¼"	
4.1.63.4	28,3	11752	66,6	23,5	8531	51,6	130	20	233	1456	1550	720	1410	1056				21,3	42,2	4x22	2x1¼"	
6.1.63.4	33,6	11080	66,6	26,5	8057	51,6	195	28	286	1456	1750	720	1610	1056				21,3	42,2	4x22	2x1¼"	
2x	3.2.40.4	13,7	6324	57,0	10,8	4234	49,0	58	10	153	1656	1220	420	1080	1256				21,3	26,7	4x22	2x1¼"
	4.2.40.4	15,6	5982	57,0	11,9	4035	49,0	78	12	170	1656	1320	420	1180	1256				21,3	26,7	4x22	2x1¼"
	6.2.40.4	17,3	5411	57,0	12,9	3695	49,0	117	18	209	1656	1520	420	1380	1256				21,3	33,7	4x22	2x1¼"
	3.2.45.4	19,4	9438	58,9	15,8	6577	47,9	78	12	172	1656	1270	520	1130	1256				21,3	33,7	4x22	2x1¼"
	4.2.45.4	22,2	8871	58,9	17,7	6261	47,9	104	16	196	1656	1370	520	1230	1256				21,3	33,7	4x22	2x1¼"
	6.2.45.4	24,9	7966	58,9	19,4	5739	47,9	156	22	240	1656	1570	520	1430	1256				21,3	33,7	4x22	2x1¼"
	3.2.50.4	28,7	14152	61,7	23,4	9699	52,7	117	18	248	2256	1320	520	1180	1856				21,3	42,2	4x22	2x1¼"
	4.2.50.4	33,8	13636	61,7	26,4	9299	52,7	156	22	280	2256	1420	520	1280	1856				21,3	42,2	4x22	2x1¼"
	6.2.50.4	39,1	12735	61,7	29,0	8577	52,7	234	34	344	2256	1620	520	1480	1856				21,3	42,2	4x22	2x1¼"
	3.2.56.4	40,4	19856	65,4	32,3	13511	53,4	162	24	298	2456	1380	620	1240	2056				21,3	42,2	4x22	2x1¼"
4.2.56.4	47,4	19232	65,4	36,8	13043	53,4	216	30	340	2456	1480	620	1340	2056				26,7	42,2	4x22	2x1¼"	
6.2.56.4	55,3	18177	65,4	40,9	12179	53,4	324	46	423	2456	1680	620	1540	2056				26,7	42,2	4x22	2x1¼"	
3.2.63.4	49,1	24214	69,2	41,0	17552	54,2	195	28	349	2456	1450	720	1310	2056				26,7	42,2	4x22	2x1¼"	
4.2.63.4	56,8	23487	69,2	46,9	17049	54,2	259	36	398	2456	1550	720	1410	2056				26,7	48,3	4x22	2x1¼"	
6.2.63.4	67,1	22139	69,2	52,2	16099	54,2	389	54	495	2456	1750	720	1610	2056				26,7	48,3	4x22	2x1¼"	
3x	3.3.45.4	28,7	14147	60,4	23,4	9860	49,4	117	18	235	2256	1270	520	1130	1856				21,3	42,2	4x22	2x1¼"
	4.3.45.4	33,3	13296	60,4	26,5	9385	49,4	156	22	267	2256	1370	520	1230	1856				21,3	42,2	4x22	2x1¼"
	6.3.45.4	37,3	11938	60,4	29,1	8602	49,4	234	34	331	2256	1570	520	1430	1856				21,3	42,2	4x22	2x1¼"
	3.3.50.4	43,6	21224	63,1	35,1	14546	54,1	175	26	346	3156	1320	520	1180	2756				26,7	42,2	4x22	2x1¼"
	4.3.50.4	50,7	20447	63,1	39,4	13943	54,1	233	34	393	3156	1420	520	1280	2756				26,7	42,2	4x22	2x1¼"
	6.3.50.4	58,5	19095	63,1	43,5	12858	54,1	350	50	486	3156	1620	520	1480	2756				26,7	48,3	4x22	2x1¼"
	3.3.56.4	60,8	29778	66,8	48,8	20261	54,8	243	34	427	3456	1380	620	1240	3056	1028	2028		26,7	48,3	4x22	2x1¼"
	4.3.56.4	70,5	28840	66,8	55,2	19560	54,8	324	46	488	3456	1480	620	1340	3056	1028	2028		26,7	48,3	4x22	2x1¼"
	6.3.56.4	83,0	27257	66,8	61,5	18261	54,8	486	68	609	3456	1680	620	1540	3056	1028	2028		33,7	60,3	4x22	2x1¼"
	3.3.63.4	73,8	36315	70,6	60,8	26322	55,6	292	42	503	3456	1450	720	1310	3056	1028	2028		33,7	60,3	4x22	2x1¼"
4.3.63.4	86,3	35223	70,6	70,2	25569	55,6	389	54	574	3456	1550	720	1410	3056	1028	2028		33,7	60,3	4x22	2x1¼"	
6.3.63.4	100,5	33197	70,6	79,4	24141	55,6	583	82	716	3456	1750	720	1610	3056	1028	2028		33,7	60,3	4x22	2x1¼"	

* Sound pressure indication (LpA) at 3 m distance each air cooler (+/- 2 dB(A)), free field conditions, according EN13487
Capacities and air volumes with 60 Hz fans on request or in our GPC selection program available.

Attention!



The fans are mounted to the outside of the air cooler. The fans are as standard not wired on a junction box to the connection side. Wiring is available against an extra price.



Best of both worlds

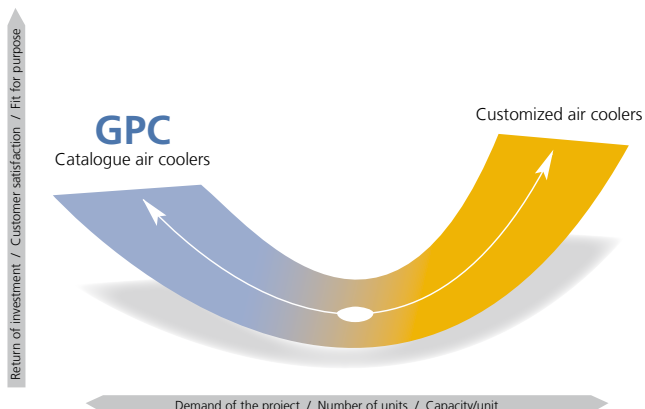

One question which always is in the mind of an industrial refrigeration engineer is the following:
Do I ask for standard or shall I go for tailor made?

There are good reasons for both choices. In some cases, the solution needed is beyond the boundaries of the standard program. In other occasions, tailor made can even offer a more economical solution. In again other situations standard would be the logical choice to go for.

In any of the cases GEA Goedhart can offer you the right solution. With the standard selection software GPC finding the right heat exchanger is just a few mouse clicks away. On other cases the GEA Goedhart engineers are happy to help you out!

Goedhart GPC Program,
your selection software
for air coolers and air
cooled condensers!

Goedhart DRS air cooler selections are available in the Goedhart Product Catalogue or GPC.

On the tool section of www.goedhart.nl you will find the download button for the latest version of the GPC.

The GPC program is an easy to use tool for contractors, consultants and every other thinkable user and gives you access to many advantages such as:

- Multilingual
- The whole range of GEA Goedhart standard air coolers and air cooled condensers
- Pre-select buttons to application
- Selections including drawings and an extensive list of accessories
- Spare parts
- Accurate capacities: Under the GPC shell hides a sophisticated capacity calculation program which optimizes circuits to the design conditions as you work!



For Contractors and Original Equipment Manufacturers (OEM) related to the industrial refrigeration industry, GEA Goedhart B.V. offers an unlimited range of air coolers and air cooled condensers in several configurations.

Depending on the application, the optimum configuration will be selected in close cooperation with our customers.

Configurations

The following material combinations are available in various tube pitches and various fin spacing:

Tube material	Fin material
Copper (Cu)	Aluminium (Al)
Stainless steel (Stst)	Aluminium (Al)
Stainless steel (Stst)	Stainless steel (Stst)
Aluminium (Al)	Aluminium (Al)
Hot dipped galvanized steel (FeZn)	Hot dipped galvanized steel (FeZn)

Options on aluminium fins

- Goldlack coated fins
- Seawater resistant aluminium fins (AlMg)

Applications

Cooling	Freezing
Cold stores / Distribution centres	Cold stores / Distribution centres
Food processing rooms	Tunnel / spiral freezers
Fruit storage	Slaughter houses
Banana ripening storage	Automotive testing rooms
Greenhouse conditioning	Ski domes

Pressure Equipment Directive (P.E.D.)

All aircoolers produced by Goedhart comply with the Pressure Equipment Directive 97/23/EC. PED certificates can be downloaded from www.goedhart.nl.

GEA Goedhart air coolers for every application





Excellence

Passion

Integrity

Responsibility

GEA-versity

GEA Group is a global mechanical engineering company with multi-billion euro sales and operations in more than 50 countries. Founded in 1881 the company is one of the largest providers of innovative equipment and process technology. GEA Group is listed in the STOXX Europe 600 Index.



GEA Heat Exchangers

GEA Goedhart B.V.

Nijverheidsweg 6, 4695 RC Sint Maartensdijk
The Netherlands
Phone +31 (0)166 665 665, Fax+31 (0)166 663 698
www.goedhart.nl,
info.goedhart.nl@geagroup.com

GEA Heat Exchangers

GEA Goedhart s.r.o.

Kostomlátecká 180, 288 26 Nymburk
Czech Republic
Phone +420 325 519 951, Fax+420 325 519 952
www.goedhart.cz,
goedhart.cz@geagroup.com